

Silicon Bipolar MMIC 5 GHz Active Double Balanced Mixer/IF Amp

Technical Data

IAM-81008

Features

- **RF-IF Conversion Gain From 0.05–5 GHz**
- **IF Conversion Gain From DC to 1 GHz**
- **Low Power Dissipation:**
65 mW at $V_{CC} = 5\text{ V}$ Typical
- **Single Polarity Bias Supply:**
 $V_{CC} = 4\text{ to }8\text{ V}$
- **Load-insensitive Performance**
- **Conversion Gain Flat Over Temperature**
- **Low LO Power Requirements:**
–5 dBm Typical
- **Low Cost Plastic Surface Mount Package**

Typical applications include frequency down conversion, modulation, demodulation and phase detection. Markets include fiber-optics, GPS satellite navigation, mobile radio, and battery powered communications receivers.

The IAM series of Gilbert multiplier-based frequency converters is fabricated using HP's 10 GHz, f_T , 25 GHz f_{MAX} ISOSAT™-I silicon bipolar process. This process uses nitride self alignment, submicrometer lithography, trench isolation, ion implantation, gold metallization and polyimide inter-metal dielectric and scratch protection to achieve excellent performance, uniformity and reliability.

Plastic SO-8 Package

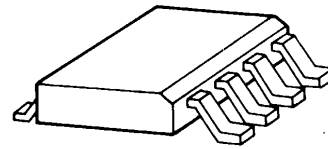

Pin Configuration

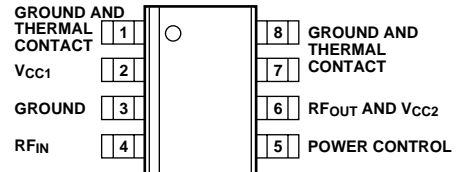

Description

The IAM-81008 is a complete low power consumption, double balanced active mixer housed in a miniature low cost plastic surface mount package. It is designed for narrow or wide bandwidth commercial and industrial applications having RF inputs up to 5 GHz. Operation at RF and LO frequencies less than 50 MHz can be achieved using optional external capacitors to ground. The IAM-81008 is particularly well suited for applications that require load-insensitive conversion and good spurious signal suppression with minimum LO and bias power consumption.

Typical Biasing Configuration and Functional Block Diagram

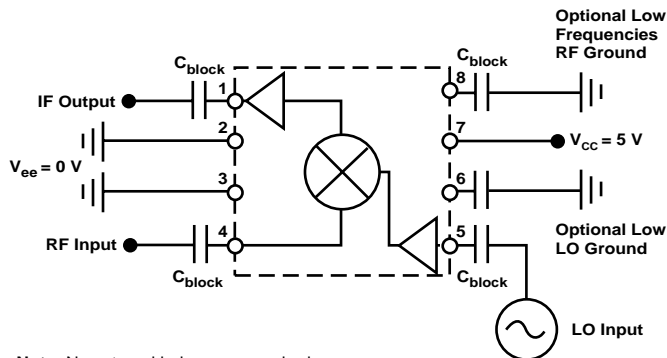

Note: No external baluns are required.

IAM-81008 Absolute Maximum Ratings

Parameter	Absolute Maximum ^[1]
Device Voltage	10 V
Power Dissipation ^{2,3}	300 mW
RF Input Power	+14 dBm
LO Input Power	+14 dBm
Junction Temperature	150°C
Storage Temperature	-65 to 150°C

Thermal Resistance:

$$\theta_{jc} = 80^{\circ}\text{C/W}$$

Notes:

1. Permanent damage may occur if any of these limits are exceeded.
2. $T_{\text{CASE}} = 25^{\circ}\text{C}$.
3. Derate at 4.4 mW/°C for $T_{\text{C}} > 82^{\circ}\text{C}$.

IAM-81008 Part Number Ordering Information

Part Number	Devices Per Reel	Reel Size
IAM-81008-TR1	1000	7"

For more information, see "Tape and Reel Packaging for Semiconductor Devices".

IAM-81008 Electrical Specifications^[1], $T_{\text{A}} = 25^{\circ}\text{C}$

Symbol	Parameters and Test Conditions: $V_{\text{cc}} = 5 \text{ V}$, $Z_0 = 50 \Omega$, LO = -5 dBm, RF = -20 dBm	Units	Min.	Typ.	Max.
G_{C}	Conversion Gain RF = 2 GHz, LO = 1.75 GHz	dB	6.0	8.5	10
$F_{3 \text{ dB RF}}$	RF Bandwidth (G_{C} 3 dB Down) IF = 250 MHz	GHz		3.5	
$F_{3 \text{ dB IF}}$	IF Bandwidth (G_{C} 3 dB Down) LO = 2 GHz	GHz		0.6	
$P_{1 \text{ dB}}$	IF Output Power at 1 dB Gain Compression RF = 2 GHz, LO = 1.75 GHz	dBm		-6	
IP_3	IF Output Third Order Intercept Point RF = 2 GHz, LO = 1.75 GHz	dBm		3	
NF	SSB Noise Figure RF = 2 GHz, LO = 1.75 GHz	dB		17	
VSWR	RF Port VSWR $f = 0.05$ to 3.5 GHz			1.5:1	
	LO Port VSWR $f = 0.05$ to 3.5 GHz			2.0:1	
	IF Port VSWR $f < 1$ GHz			1.5:1	
RF_{if}	RF Feedthrough at IF Port RF = 2 GHz, LO = 1.75 GHz	dBc		-25	
LO_{if}	LO Leakage at IF Port LO = 1.75 GHz	dBm		-25	
LO_{rf}	LO Leakage at RF Port LO = 1.75 GHz	dBm		-30	
I_{CC}	Supply Current	mA	10	13	16

Note:

1. The recommended operating voltage range for this device is 4 to 8 V. Typical performance as a function of voltage is on the following page.

IAM-81008 Typical Performance, $T_A = 25^\circ\text{C}$, $V_{CC} = 5\text{ V}$
RF: -20 dBm at 2 GHz , LO: -5 dBm at 1.75 GHz
(unless otherwise noted)

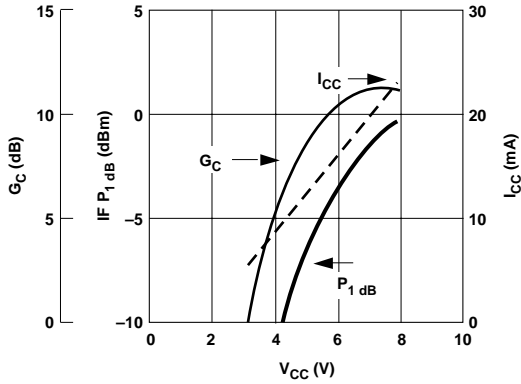

Figure 1. Conversion Gain, IF $P_1\text{ dB}$ and I_{CC} Current vs. V_{CC} Bias Voltage.

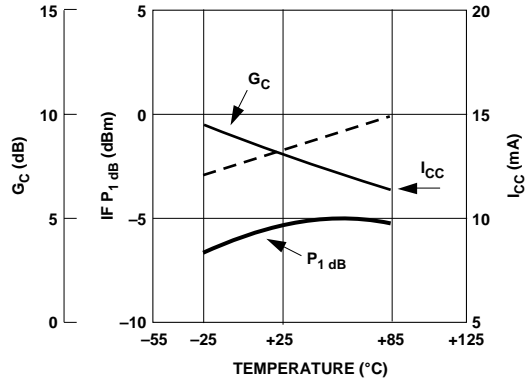

Figure 2. Conversion Gain, IF $P_1\text{ dB}$ and I_{CC} Current vs. Case Temperature.

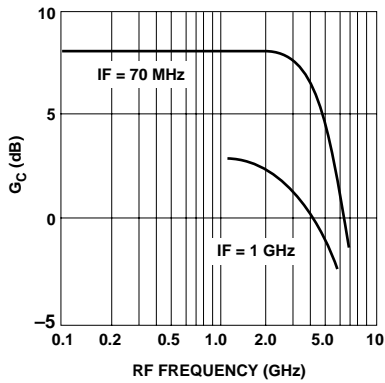

Figure 3. Typical RF to IF Conversion Gain vs. RF Frequency, $T_A = 25^\circ\text{C}$ (Low Side LO).

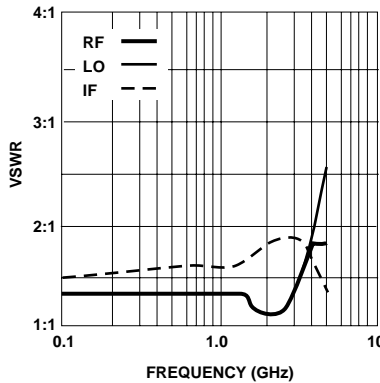

Figure 4. RF, LO and IF Port VSWR vs. Frequency.

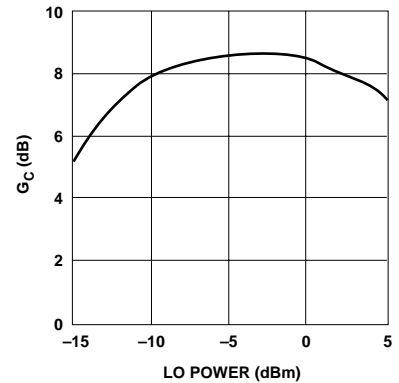

Figure 5. RF to IF Conversion Gain vs. LO Power.

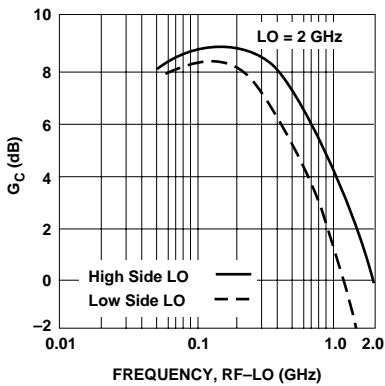

Figure 6. RF to IF Conversion Gain vs. IF Frequency.

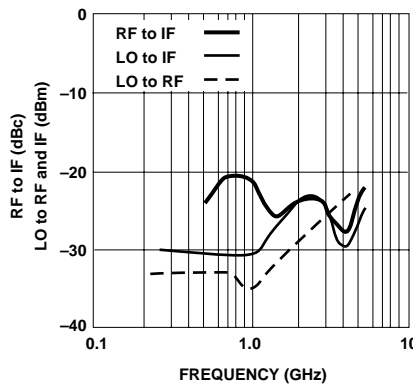

Figure 7. RF Feedthrough Relative to IF Carrier, dBm LO to RF and IF Leakage vs. Frequency.

0	—	21	35	74	>75	>75	
1	18	0	45	48	>75	>75	
2	16	35	42	72	>75	>75	
3	42	20	44	59	>75	>75	
4	29	44	52	64	>75	>75	
5	45	36	57	64	>75	>75	
		0	1	2	3	4	5

HARMONIC LO ORDER

HARMONIC RF ORDER

$X_{mn} = P_{if} - P(m^{*}rf - n^{*}lo)$

Figure 8. Harmonic Intermodulation Suppression (dB Below Desired Output) RF at 1 GHz , LO at 0.752 GHz , IF at 0.248 GHz .

Package Dimensions

SO-8 Plastic Package

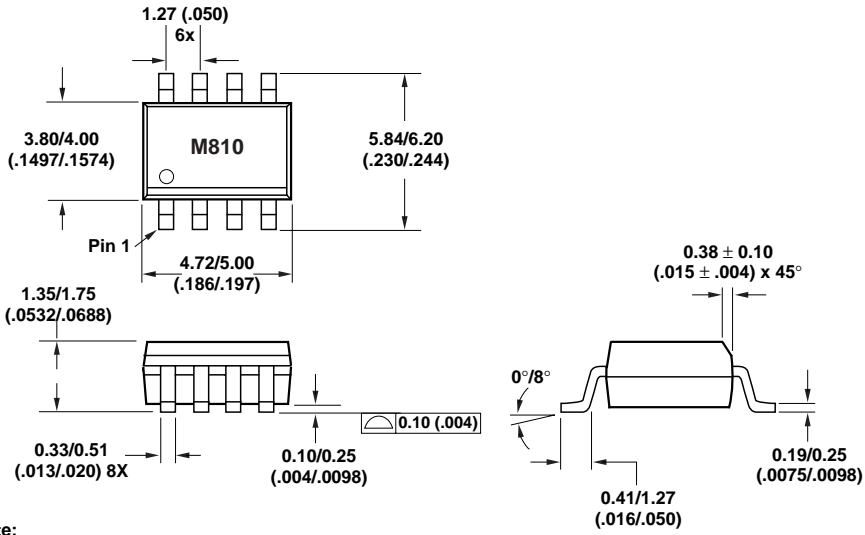

Note:
 1. Dimensions are shown in millimeters (inches).